

**RESOLUTION NO. 2017-53**

**A RESOLUTION AUTHORIZING THE CITY MANAGER TO ACCEPT THE PROPOSAL AND ENTER INTO AN AGREEMENT WITH CLASSICAL CONSTRUCTION LLC FOR LABOR AND MATERIALS RELATED TO THE FABENS PARK SHELTER BUILDING PROJECT AT A COST NOT TO EXCEED ONE HUNDRED THIRTY SIX THOUSAND SEVEN HUNDRED EIGHTY AND 00/100 DOLLARS (\$136,780.00)**

**BE IT RESOLVED BY THE COUNCIL OF THE CITY OF HURON, OHIO:**

**SECTION 1.** That the City having issued a Request for Proposals on June 12, 2017, the City Manager is authorized and directed to accept the proposal and enter into an agreement with Classical Construction LLC for the provision of labor and materials at a cost not to exceed One Hundred Thirty Six Thousand Seven Hundred Eighty and 00/100 Dollars (\$136,780.00) which agreement shall be substantially in the form of Exhibit "A" attached hereto and made a part hereof.

**SECTION 2.** That this Council hereby finds and determines that all formal actions relative to the adoption of this Resolution were taken in an open meeting of this Council and that all deliberations of this Council and of its Committees, if any, which resulted in formal action, were taken in meetings open to the public in full compliance with applicable legal requirements, including O.R.C. §121.22.

**SECTION 3.** That this Resolution shall be in full force and effect from and immediately after its adoption.

ATTEST:   
Clerk of Council

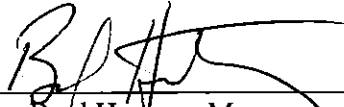
  
Brad Hartung, Mayor

ADOPTED: JUL 11 2017



**Project Scope and General Instructions:** The City of Huron is seeking qualified proposals for the construction of a 3,800 square foot shelter/storage building to be constructed at the Andrew L. Fabens Memorial Park.

To be considered, submitted proposals must address the entire scope of the project.

**Site Work:**

- Remove existing landscape mound and trees. Haul spoils off site.
- Cut and Grade new building area per site plan
- Cut and grade new access drive and concrete walk per site plan
- Install compacted stone base for concrete walk and access drive
- Seed and mulch all areas disturbed by construction
- Contractor responsible for protecting site, paving and walkways during construction

**Concrete Work:**

- Place 3000psi concrete footings as required for new pole building
- Place and finish 4" thick 4000 psi concrete floor slab with 6" compacted stone base at 40'x80' pole building and 15'x40' roof extension area.
- Place and finish 4" thick concrete sidewalk on 4" compacted stone base per site plan
- Place and finish 6" thick concrete access drive on 6" compacted stone base per site plan
- Place and finish 4'x4' concrete frost stoops with reinforced concrete footings at three (3) exterior man doors.
- Install two (2) concrete filled painted steel pipe bollards at exterior side of overhead door.

**Pole Building:**

- Furnish and erect 40'x80' clear span wood framed pole building with 12' eave height and 15'x40' roof extension area.
- Install complete metal roofing system at pole building and roof extension
- Install metal siding and soffit material at 40'x40' 'enclosed storage' section of pole building
- Install 24" high translucent siding at top of walls at 'enclosed storage' section of pole building
- Install Metal siding or liner panels at ceiling of open shelter area and roof extension area
- Install metal siding or liner panels on Interior side of 'enclosed storage' area walls
- Install four (4) hollow metal doors and frames and one 10'x10' manually operated overhead door at 'enclosed storage' area including all necessary hardware and locksets.
- Install wood stud and plywood walls at '10'x40' 'secured storage' section of enclosed area to the underside of roof trusses with plywood sheathing on bottom chord of trusses to create a light mezzanine storage area above. Install attic type combination access hatch/ladder for mezzanine access.

- Install two (2) decorative vinyl rooftop mounted cupolas on roof of pole building. Cupolas to be approximately 5' in total height.
- Install one (1) decorative vinyl gable vent on East gable face above 'open shelter' area.

The City of Huron has provided as part of this packet civil site drawings for the project which will locate the proposed building, proposed sidewalk, proposed access drive, show existing and proposed grades and locate the existing water and electrical services. All other plans: Architectural, structural, plumbing, electrical or otherwise which will be required by the City building official for review and approval are to be provided by the contractor. In addition to the above plans, the contractor is to provide material/product data and color samples to the City of Huron for review and approval prior to commencement of work.

There will not be a pre-proposal meeting, but a site visit is strongly encouraged prior to submitting a proposal. Each vendor shall provide a maximum of two (2) designs for the shelter building. Sealed proposals will be accepted until 3:00 PM, June 27, 2017, in the office of the City Manager Attn: Fabens Park Shelter Building Project, 417 Main Street, Huron, Ohio 44839. Envelopes shall be clearly marked "Fabens Park Shelter Building Project." The proposals will be reviewed internally by staff. A recommendation will be made to the Huron City Council for consideration at a future meeting. In awarding the proposal, Huron City Council reserves the right to reject any and all proposals, and to award whatever proposal determined to be in the best interest of the City of Huron, Huron Township, the Huron Joint Recreation District, and the Huron Parks and Recreation Department.

Any question regarding the site drawings or scope of the project should be directed to:

Doug Green  
 City of Huron Engineering Department  
 417 Main Street  
 Huron, Ohio 44839  
 (419) 433-5000 ext 115  
 (440) 258-7799 cellular  
[dgreen@hexagoncmc.com](mailto:dgreen@hexagoncmc.com)

**Evaluation and Scoring:** Only complete proposals will be considered for acceptance. A proposal will be deemed complete if it includes the following: unit description and unit cost for each element of the project scope; three references from prior projects, preferably municipal projects; inclusion of the necessary bid bond or performance guarantee; contractor schedule; and, signed contractor acknowledgement forms.

The City of Huron will be evaluating the bids based on the following criteria, in no specific order:

- Content of proposal
- Qualifications of the installer
- Proposal amount
- Conformity of design to city plans
- Schedule of work

FILE C:\USERS\GOTTADESIGN\WORKSPACE\PROJECTS\FABENS PARK SHELTER BUILDING\DWG - APR 27, 2017 12:14pm - Knecht Euser Engineering, Inc.

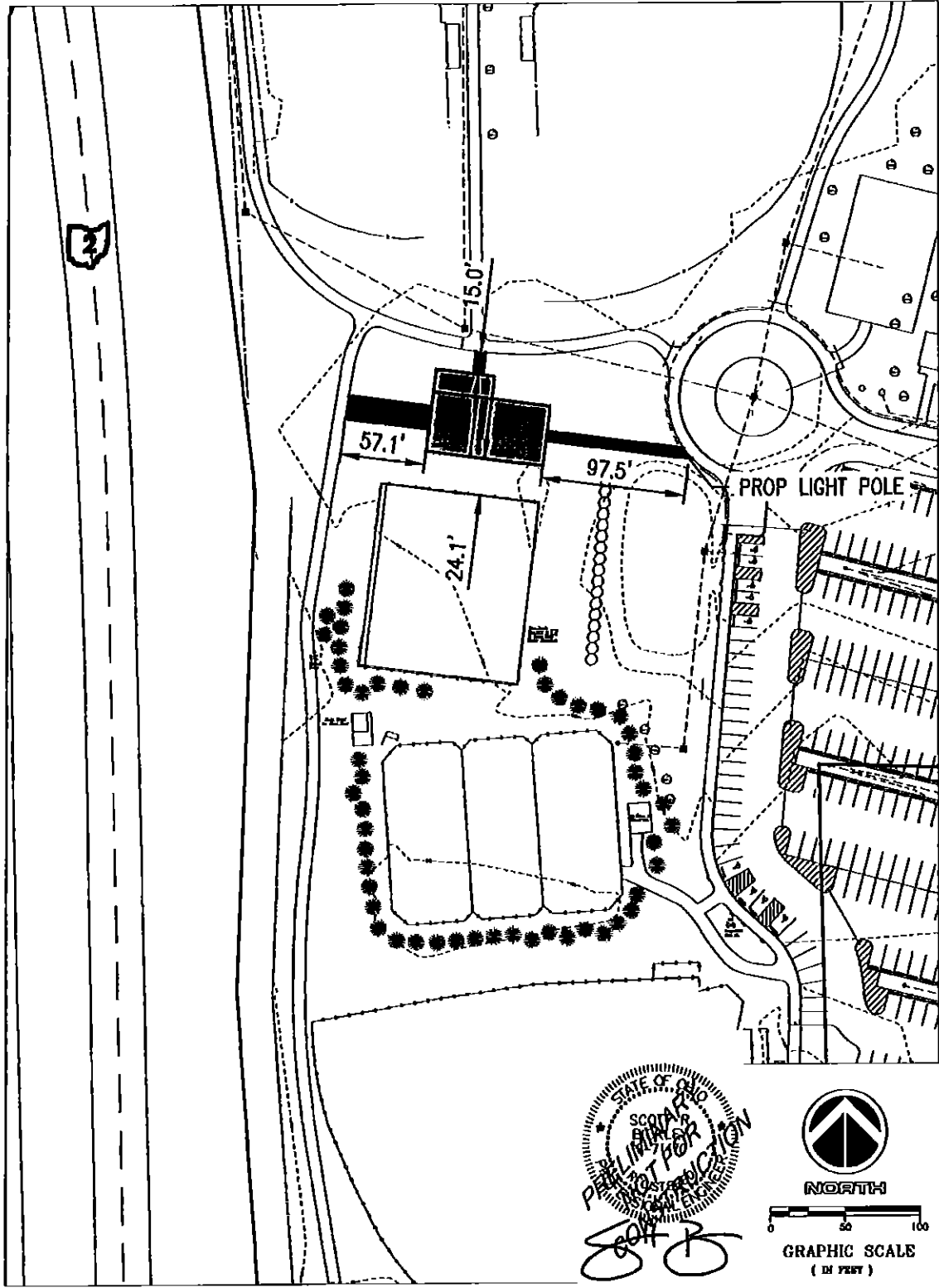

**SITE PLAN**  
 Fabens Park Shelter Building  
 CITY OF HURON



SHEET:  
 1

File C:\Users\COMPTON\Documents\FABENS PARK TRAILS\FABENS PARK TRAILS BUILDING.DWG - Apr 27, 2017 10:51am - David Eimer Engineering, Inc.

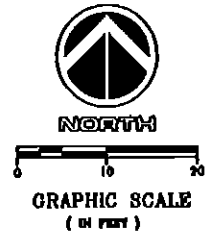
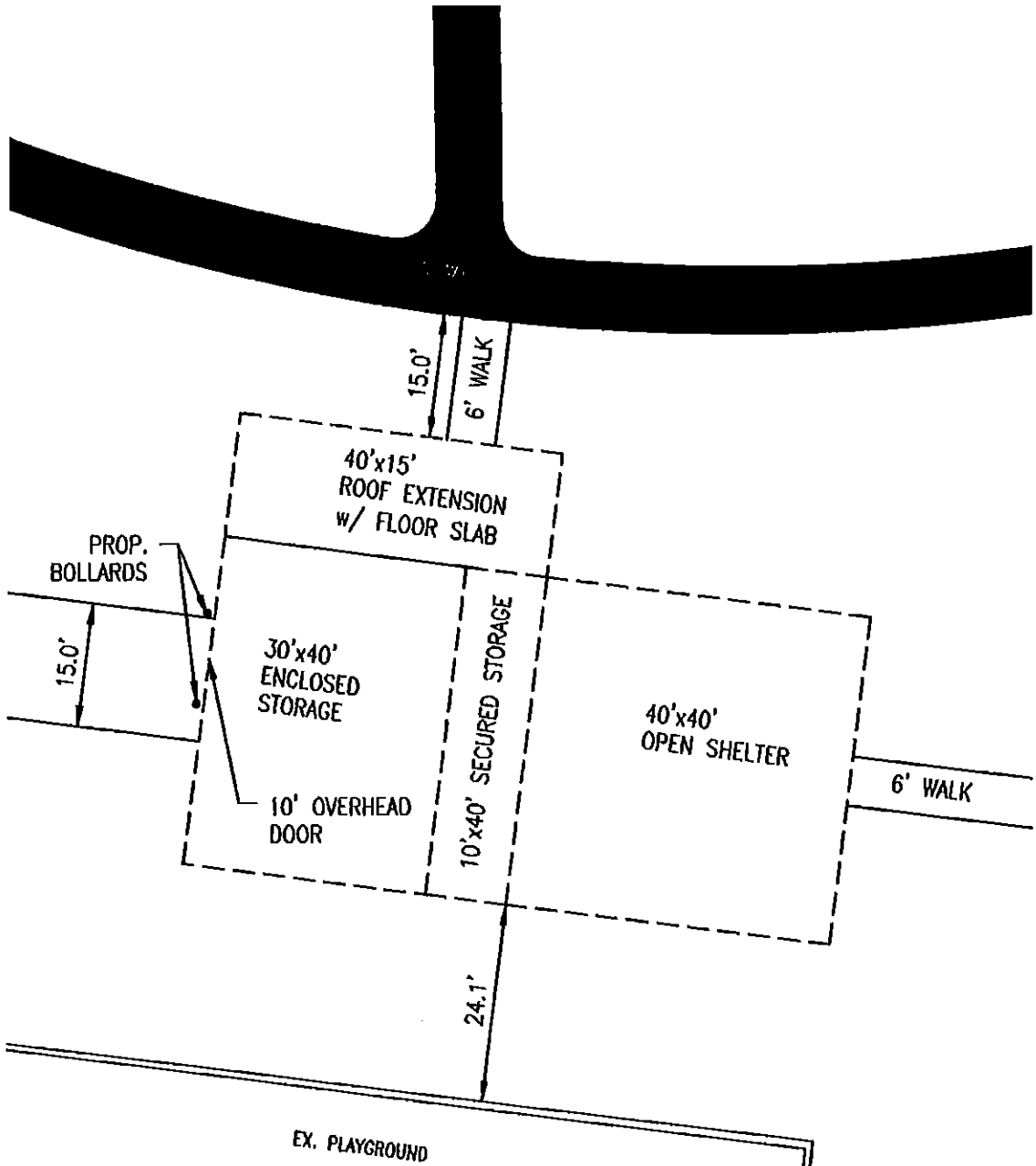

**Site Plan**  
 Fabens Park Trails  
 City Of Huron



SHEET:  
 1

File: Z:\Users\GORT\DESKTOP\YAVIUS P&C\F&V\YAVIUS P&C P&C BUILDINGS - Apr 27, 2017 11:30am - Scott Euser Engineering, Inc.

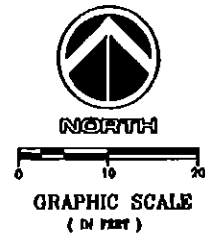
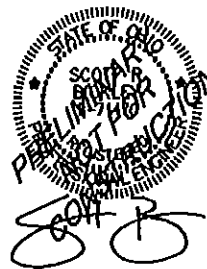
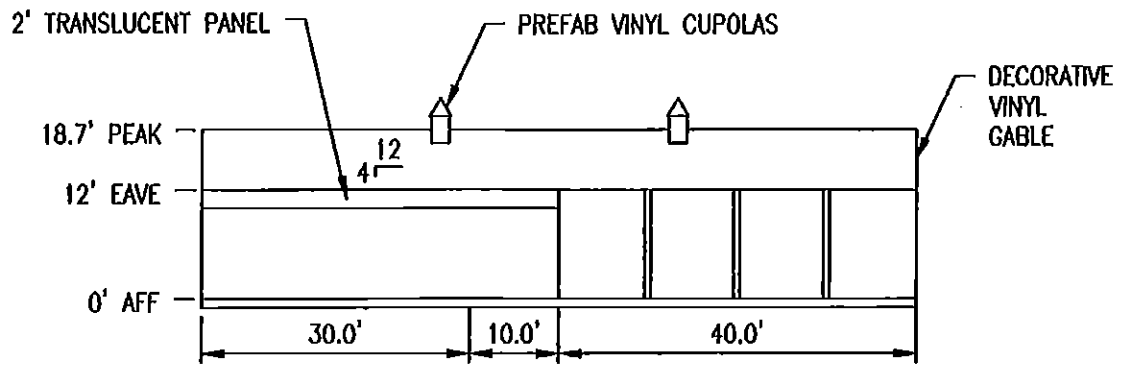
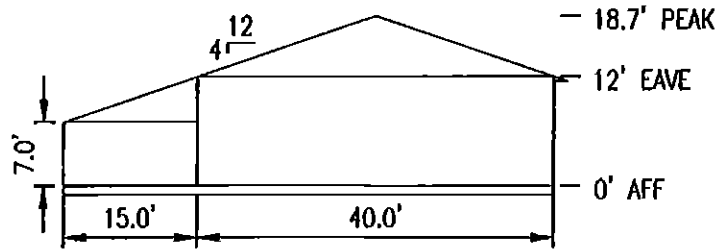

Site Plan  
Fabens Park Trails  
City Of Huron



SHEET:  
1